

KTM 790 ADVENTURE '19-

M O U N T I N G I N S T R U C T I O N S

REF 3758

HEADLIGHT PROTECTOR



ID	PIEZA/PART	DESCRIPCIÓN	DESCRIPTION	QTY	REF
1		Protector de faro	Headlight protector	1	3758WM3
2		Soporte superior	Upper support	1	SOPOR2P7-S-3758
3		Soporte inferior	Lower support	1	SOPOR2P7-I-3758
4		Silentblock Ø18x Ø9 xØ11 x8	Ø18x Ø9 x Ø11 x8 silentblock	4	SILENBGONE--064
5		Tope de goma Ø4,5-4,6 x 1,5mm	Ø4,5-4,6 x 1,5mm bumper foot	2	TOPEGOMA---3758
6		Tornillo ISO 7380 M4x8 (negro)	M4x8 ISO 7380 Allen screw	1	TORNI-I7380-757
7		Arandela nylon M4	M4 nylon washer	1	ARNV00000000311
8		Clip hexagonal M4 Ø3,96 x6,35mm	M4 Ø3,96 x6,35mm exagonal clip	1	CLIP-HEX---3758
9		Tornillo Allen M5x11 Ø11 ISO 7380	M5x11 Ø11 ISO 7380 Allen screw	1	TORNI-AI----520
10		Arandela nylon M5x1	M5x1 nylon washer	2	ARNV000000000245
11		Tornillo Allen M5x16 Ø11 ISO 7380	M5x16 Ø11 ISO 7380 Allen screw	2	TORNI-I7380-493
12		Casquillo Ø8,5 x Ø13 x3,5	Ø8,5 x Ø13 x3,5 arrowhead	2	CASQUI-----775
13		Tapón tornillo M5 ISO 7380	M5 ISO 7380 screw cap	1	TAPON-----85

KTM 790 ADVENTURE '19-

INSTRUCCIONES DE MONTAJE - MOUNTING INSTRUCTIONS - MONTAGEANLEITUNG

1

DISASSEMBLY
DESMONTAJE

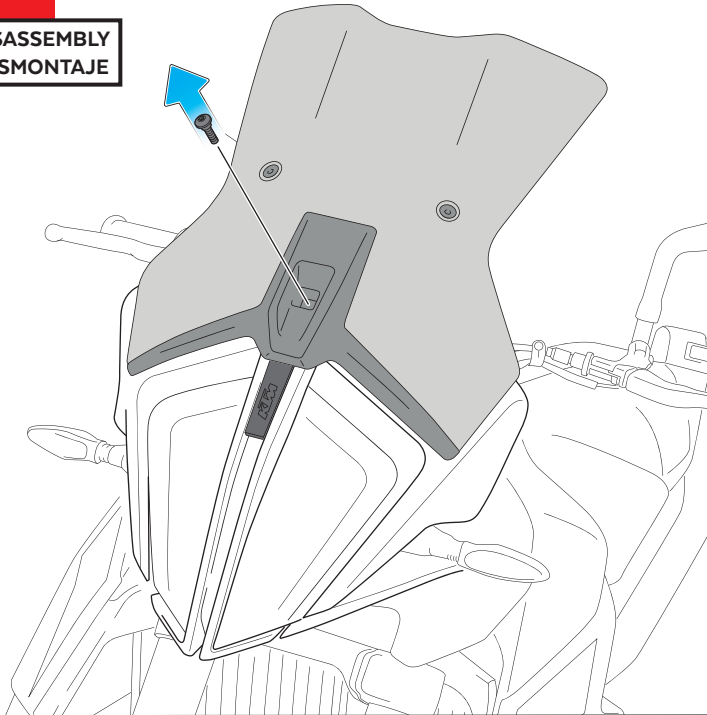

2

DISASSEMBLY
DESMONTAJE

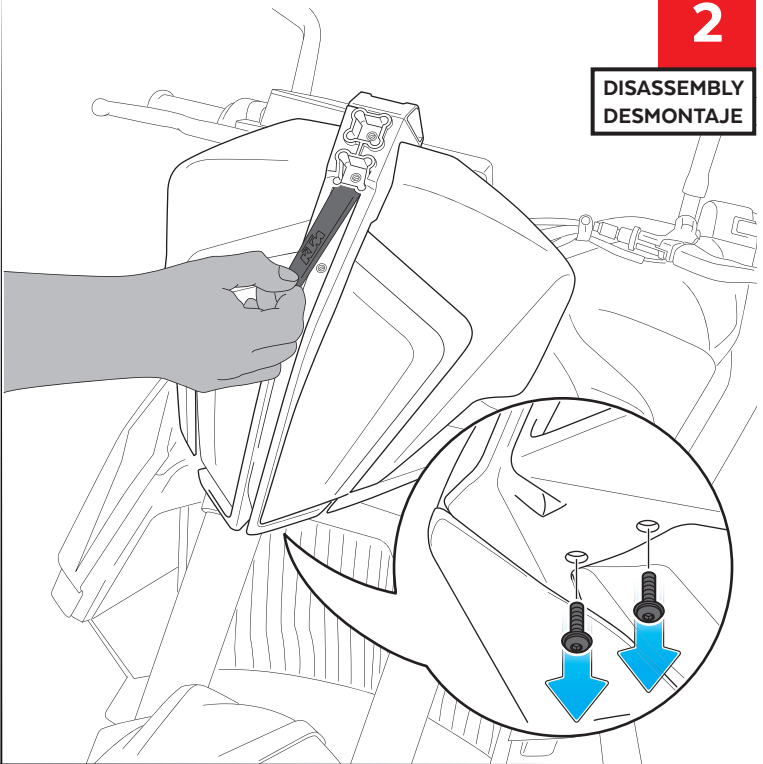

3

ASSEMBLY
MONTAJE

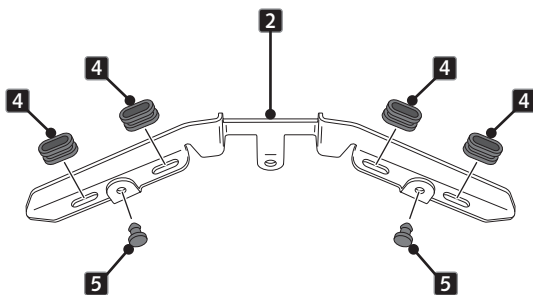

4

ASSEMBLY
MONTAJE

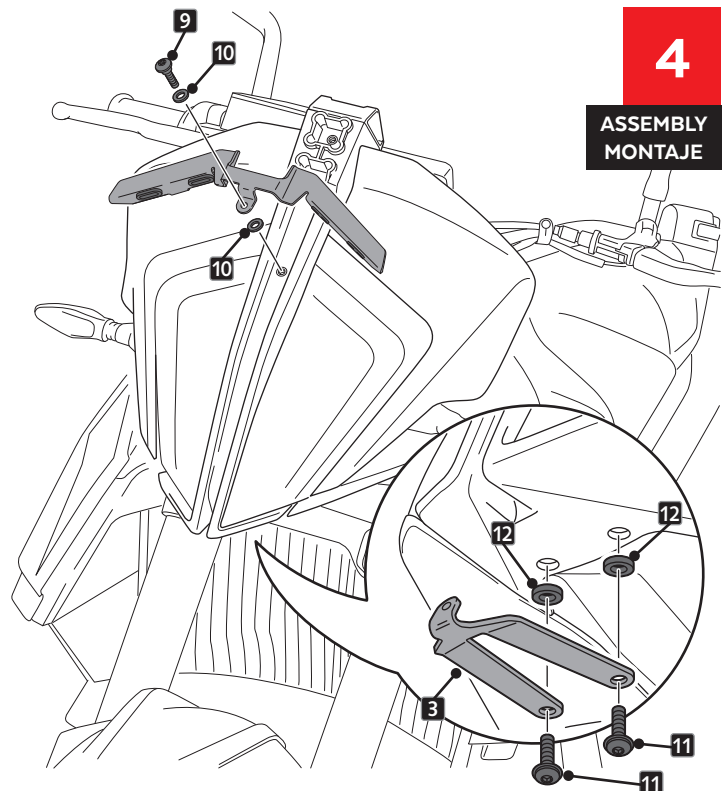

KTM 790 ADVENTURE '19-

INSTRUCCIONES DE MONTAJE - MOUNTING INSTRUCTIONS - MONTAGEANLEITUNG

5

ASSEMBLY
MONTAJE

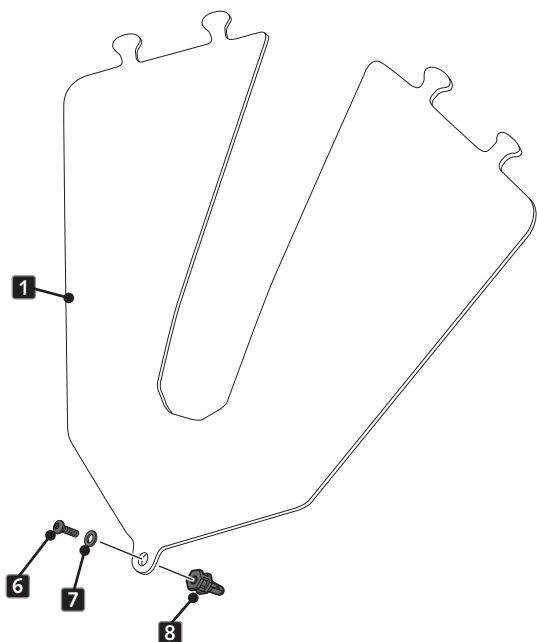

6

ASSEMBLY
MONTAJE

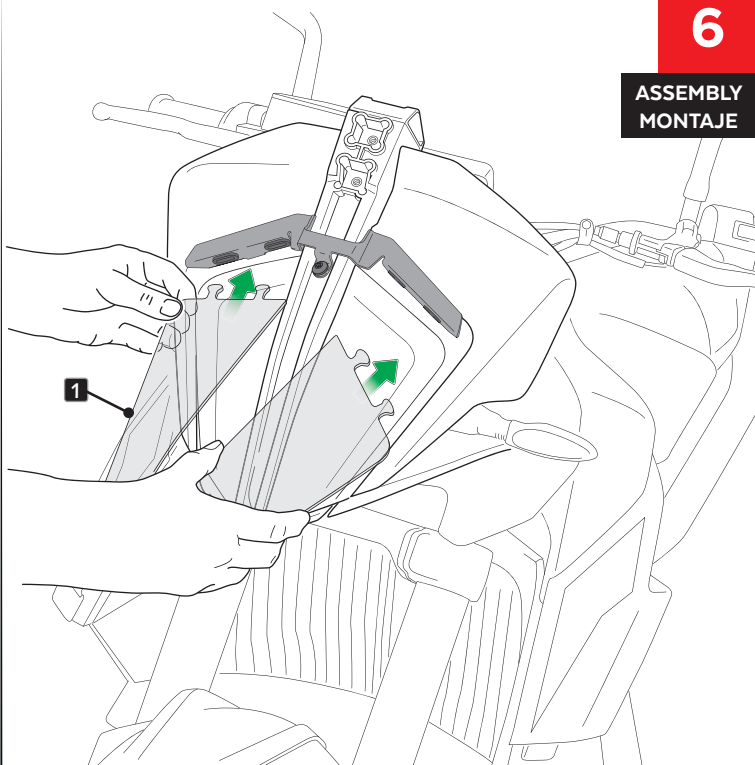

7

ASSEMBLY
MONTAJE

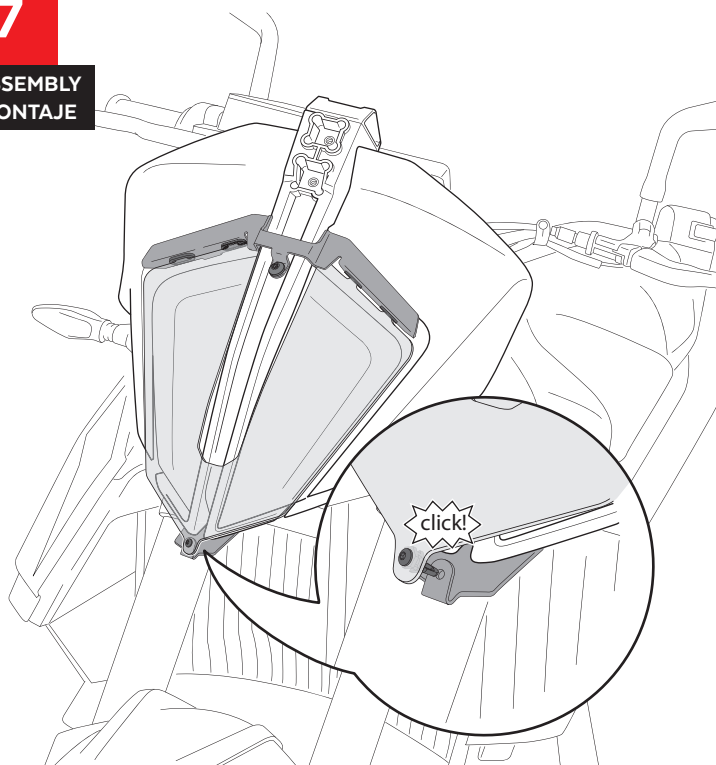

8

ASSEMBLY
MONTAJE

